

## Tool box–Borescope (option)

Through wireless borescope, you can check the interior spaces of mechanical equipment, which are difficult to observe directly with naked eyes.

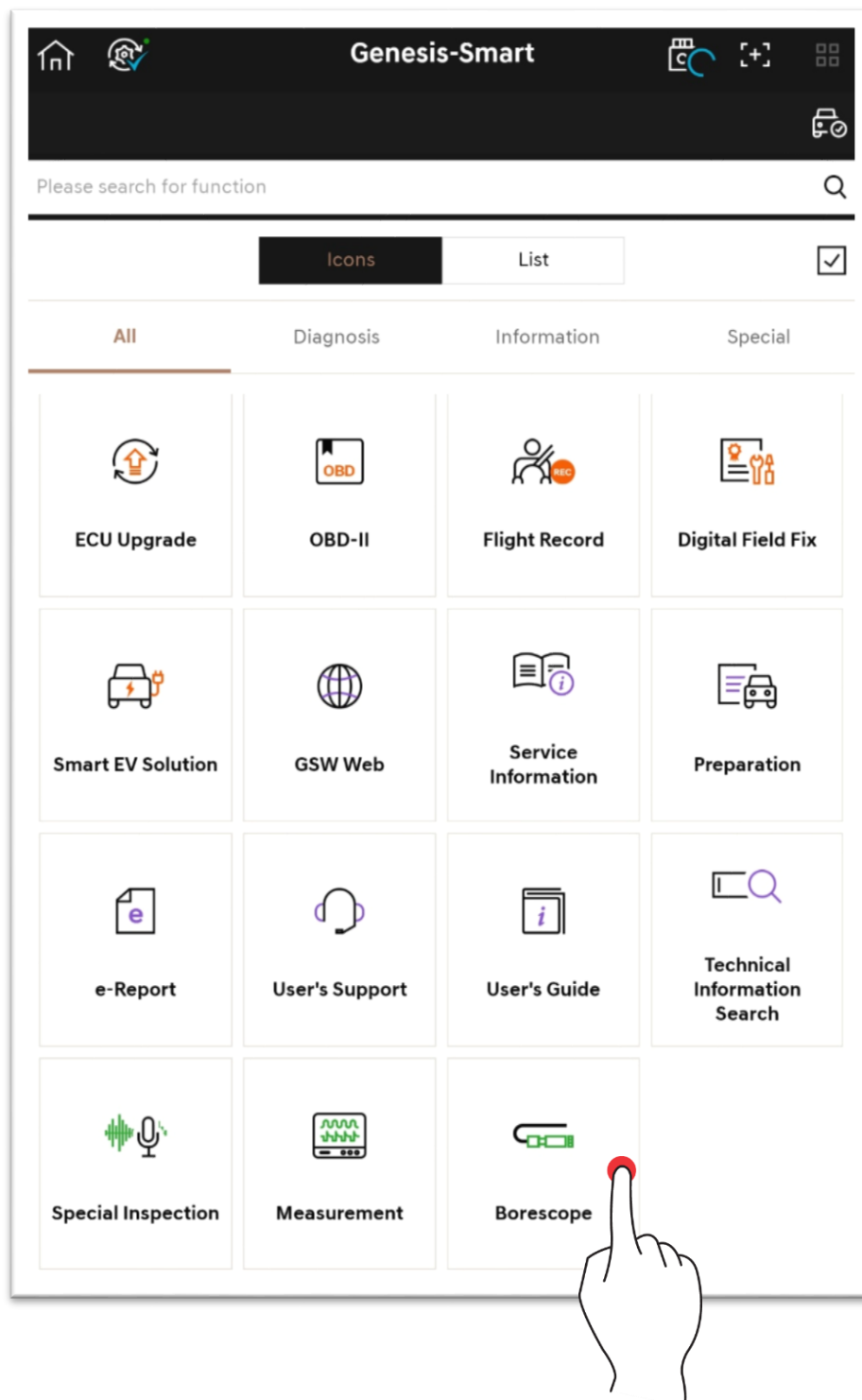

## Precautions Before Use



The user is responsible for all damages that are caused by not understanding the contents of this Wireless Borescope User Manual thoroughly or by controlling it differently from the contents of the User Manual.

- In the case of connecting to DC charger, do not use chargers other than the designated DC charger.
- Please make sure that all the cables are normally connected during the operation, and do not disconnect the communication cable or power cable before the operation completed.
- Please be cautious that you may not be able to receive a normal service, in the case where the product is arbitrarily disassembled, modified or remodeled.
- Make sure to use genuine products manufactured at GIT Co., Ltd. for cables, chargers, other parts and accessories that are used together, and also use the designated devices and programs.
- Please handle the product within the operating temperature and humidity range.
- A wireless communication failure might occur if this product is used in an excessively obstructed space. Wireless communication can be stopped temporarily or continuously depending on the wireless communication environment.
- The use of this product may be restricted in long-range communication setting as it is a short-range wireless device.







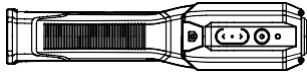
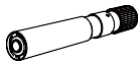
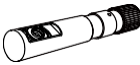

Personal injuries or material damages can occur if the user does not pay attention for handling, and more serious results may occur under certain conditions. Please comply with all safety rules and instructions.

- Please do not store the product in places where flammable materials or strong static electricity can be generated. Chemical or acid substances may cause corrosion of the product and accessories. Please do not apply shock to the product.
- Please cool down the engine sufficiently (50°C or lower), and use the product at low temperature conditions.
- Please do not touch the camera part with your hands while LED lighting is turned on as it may be hot. There is a risk of burns. When you use the product in the vehicle's engine room, pay attention to damages caused by high-temperature and moving parts.
- Please make sure that the main body that contains the charging battery and cables does not make contact with water. Please do not disassemble the charging battery.

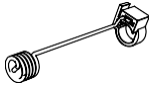
- Pay attention to prevent water leak caused by inappropriate use of the charging battery from making contact with your eyes or skin. Make sure to use only the designated product for the charging battery.
- Pay attention to prevent connections of the camera and charging cables from making contact with water. Be cautious for storing all components when not in use.
- Please do not pull the cables when moving or using the product.
- GIT Co., Ltd. is not responsible for damages caused by using a PC that is not recommended by the company.
- Please do not expose the product to X-ray or microwave. Serious damages might occur to the product. Please do not store the product in the following places:
  - Places where temperature or humidity is too high (please check the specification of the product).
  - Places that are exposed to direct light for a long time
  - Inside the vehicle during summer
  - Places having a lot of moisture

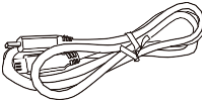
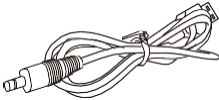
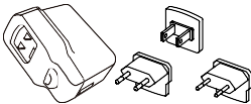
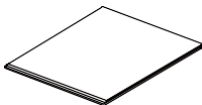
## Basic Configuration Items



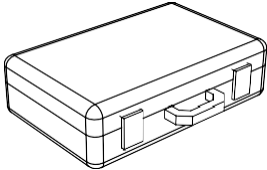



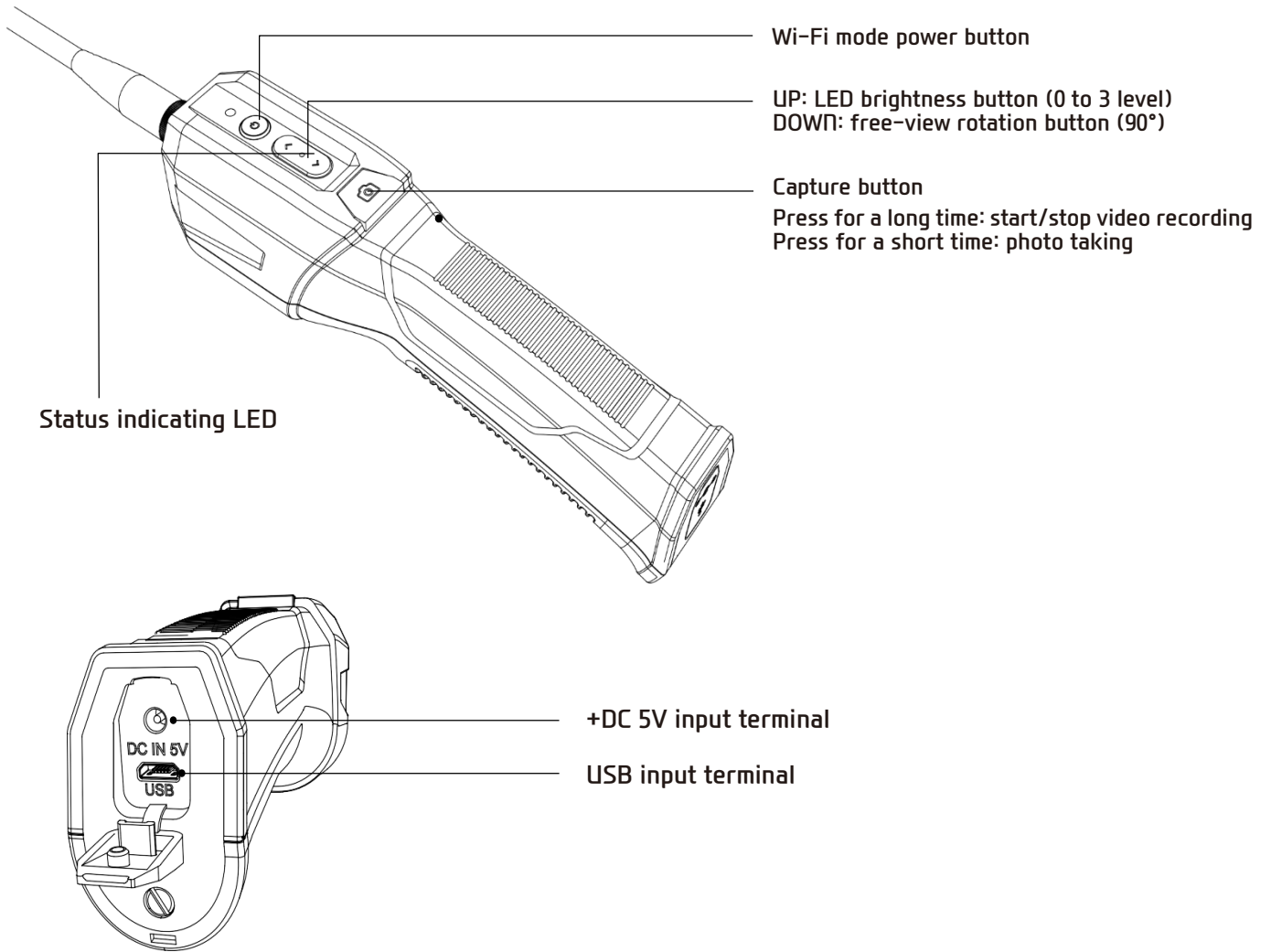

Item	Image	Description
Main Body		The Main Body performs the borescope function by connecting with the camera and Flexible Tube.
0° Camera		This is a 0° camera used for taking the front view.
90° Camera		This is a 90° camera used for taking the side views.
Flexible Tube		This is a probe used to connect the Main Body with the camera.
0° Magnetic Holder		You can lift small bolts or screws by mounting it on the camera lens home.
90° Magnetic Holder		You can lift small bolts or screws by mounting it on the camera lens home.
Micro USB Cable		This is a cable used to perform wire communication between the borescope and tablet. Cable length: 150 cm
DC Cable		This is a jack used to supply power to VCI, using DC power adaptor.
Charger and Plug		This is used for charging by connecting DC cable. Plug: 1 type out of 3 types is provided.
Manual		This is Wireless Borescope User Manual, which contains methods of using the product safety and normally, as well as the product specification, etc. (the specification may vary depending on situation.)
USB C-type Gender		This is a c-type gender that can replace 5-pin cable.
Cleaning Fabric		This is a cleaning fabric for wiping the camera lens.

<p>Container</p>		<p>This is a container for carrying and storing the Wireless Borescope product.</p>
------------------	-----------------------------------------------------------------------------------	-------------------------------------------------------------------------------------

## Name of Each Part



## Status Indicating LED

Connection Type	Status	LED	Remarks
Wi-Fi	Booting		Flashing blue light
	Booting completed/hold status for Wi-Fi connection		Flashing blue and green lights
	Connecting to Wi-Fi		Flashing green light
	Connecting to Wi-Fi completed		Green light turned on
	Low battery		Flashing red and blue lights
	When terminating the device		Flashing red light
Charge	Charging		Red light turned on
	Fully charged		Red light turned off
USB	Program connection completed		Blue light turned on

## Product Assembly

1. Plug the flexible tube to the Main Body, and fix it by rotating the screws.

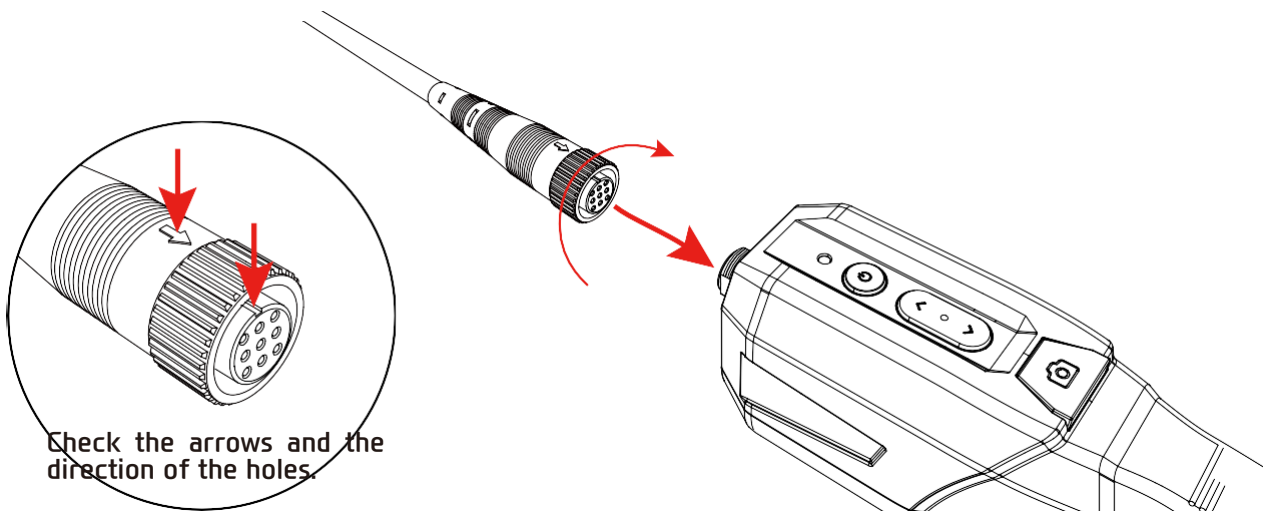

2. Mount the camera on the opposite side of the Flexible Tube, and fix it by rotating the screws.

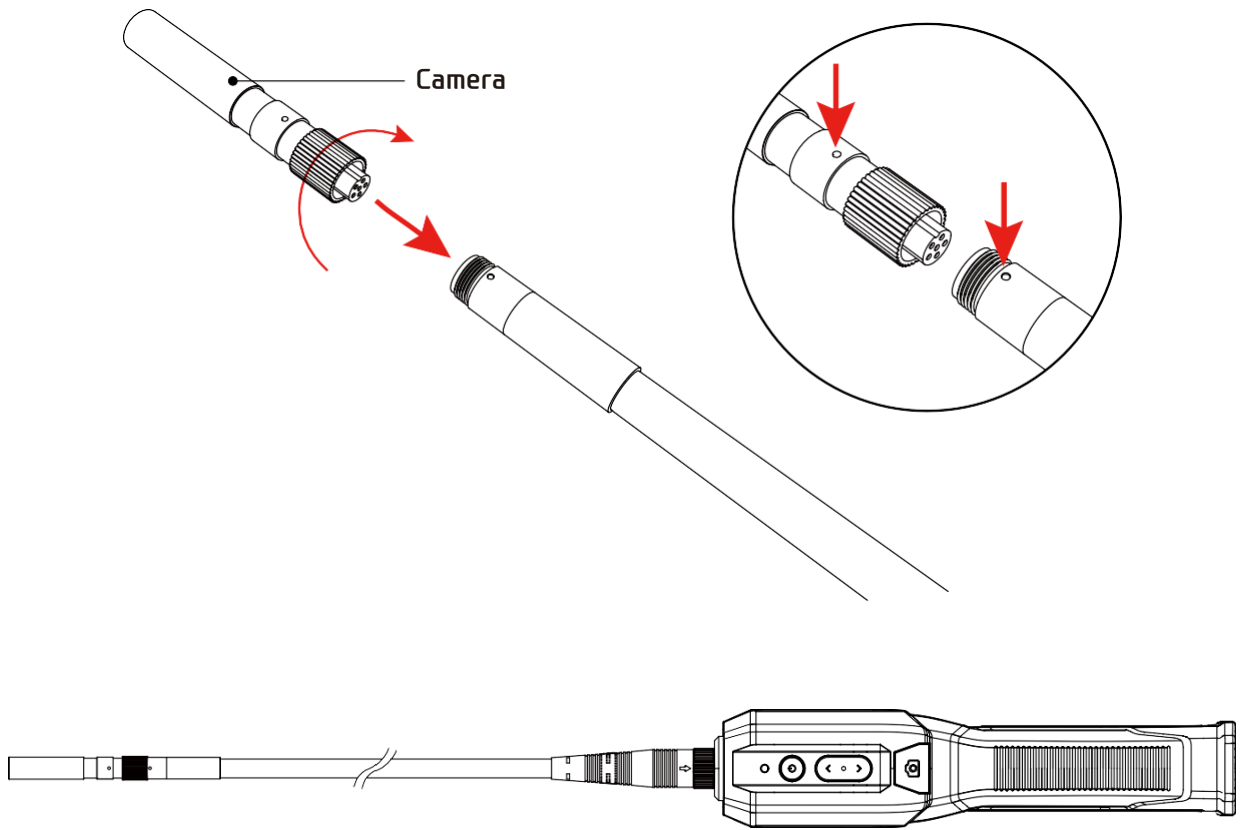

## Charging of the Product

This product requires charging as it consumes its own battery when used in wireless condition.

\* USB connection type can be used without charging.

1. Connect DC cable to 5V 2A charger.

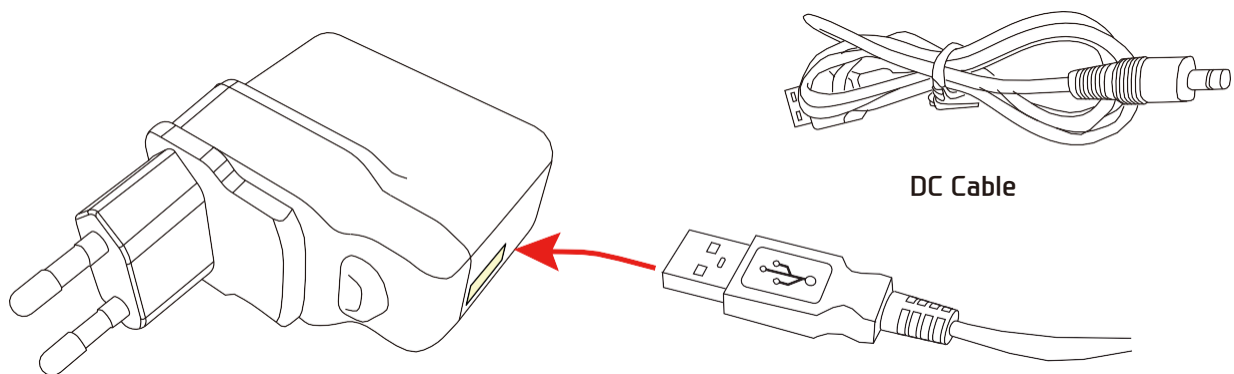

2. Peel of the waterproof cover on the rear side of the Main Body, and connect DC cable to DC input terminal.

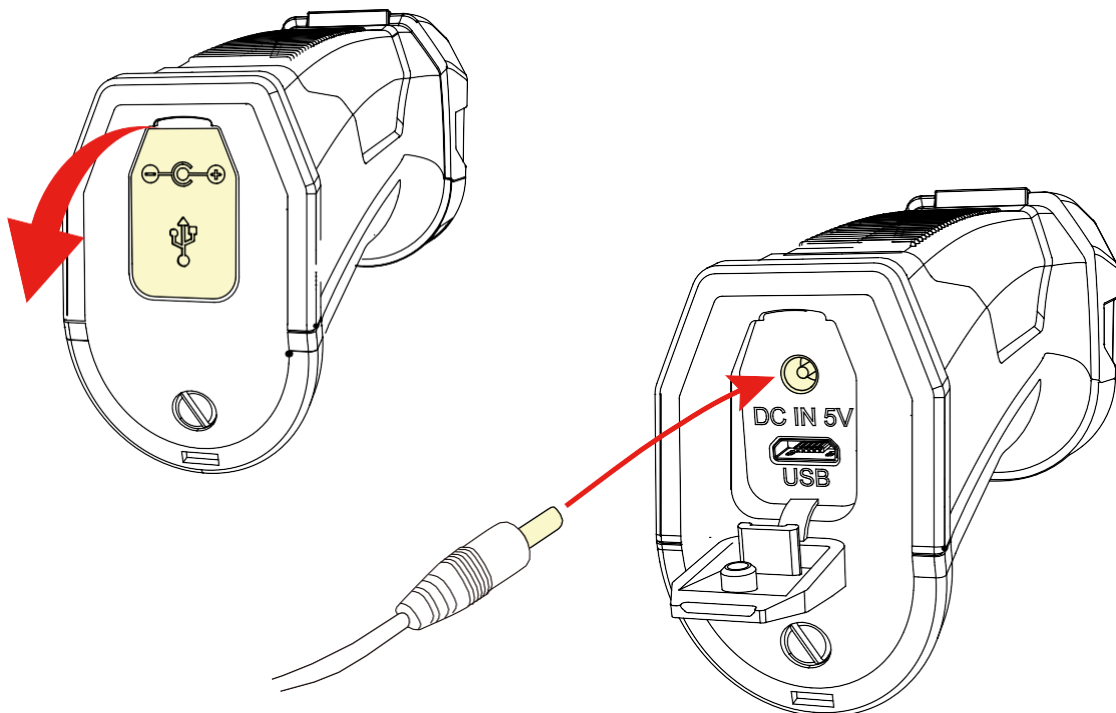

\* Power supply method

Wi-Fi mode: battery and charger

USB mode: tablet



## Diagnosis Device ↔ Product Connection

### USB Connection Method

1. If Wi-Fi power is turned on, press the Power button to turn it off.

To enter USB mode, Wi-Fi power should be turned on.

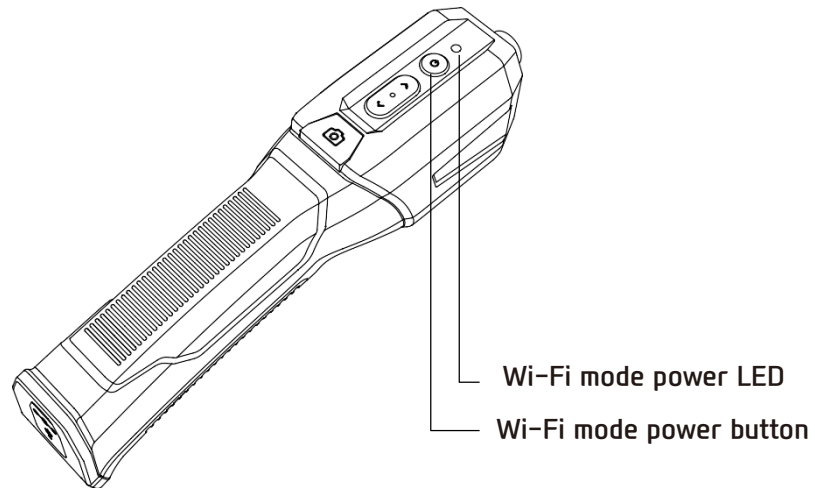

2. Use Micro USB Cable to connect the Diagnosis Device to Wireless Borescope Module.

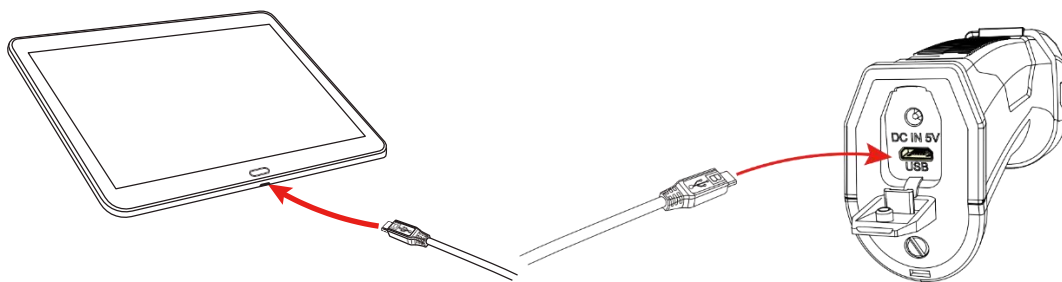

### 3. Touch the Borescope.

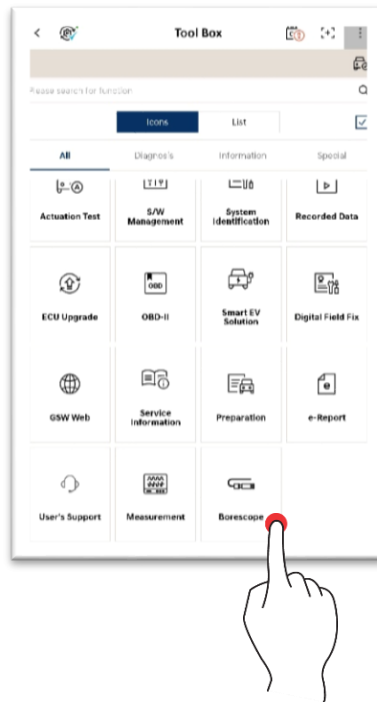

### 4. Attempt to connect USB automatically. Once USB connection is completed, the screen moves to the photo taking screen.

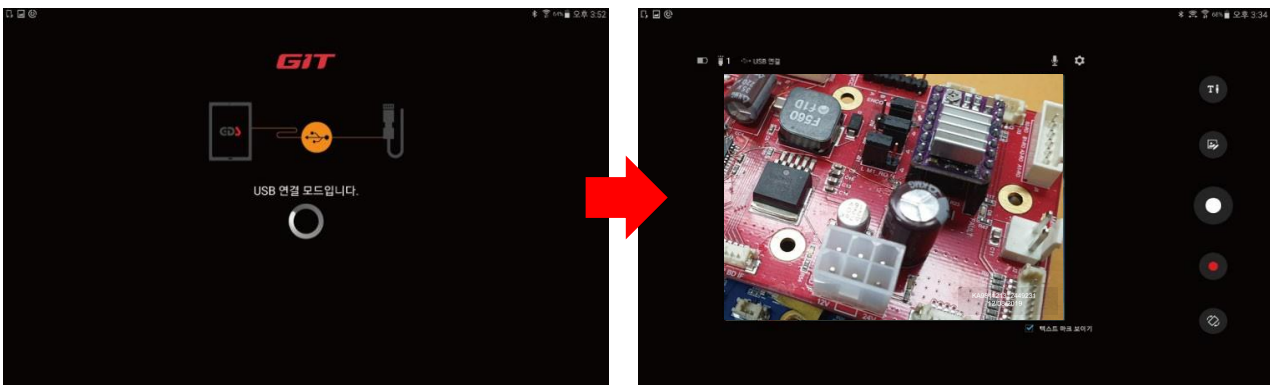

 If USB connection is failed, try connecting USB cable again.

## Wi-Fi Connection Method

1. Press  button for 3 seconds to allow the Wireless Borescope Module to enter Wi-Fi hold status.

Flashing red and green LED lights appear.

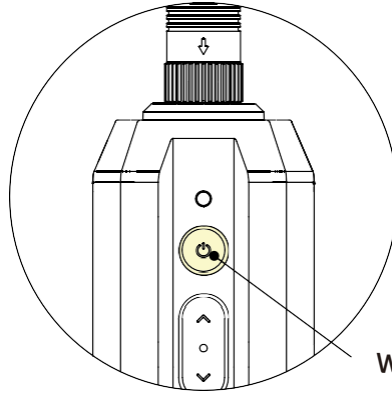

Wi-Fi mode power button

2. Run the Wireless Borescope, and enter 4-digit code indicated on the device label.

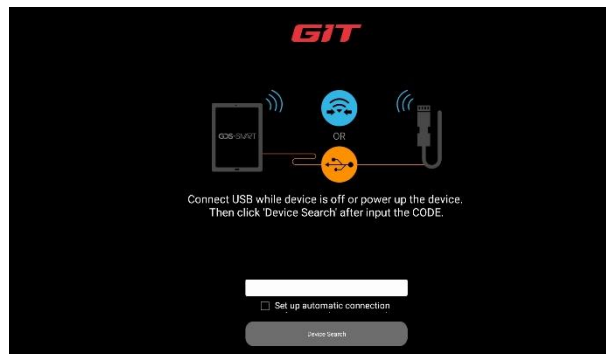
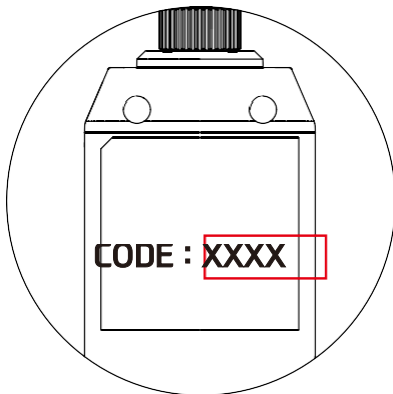

3. Once the device is searched, press Connect button to complete the connection.

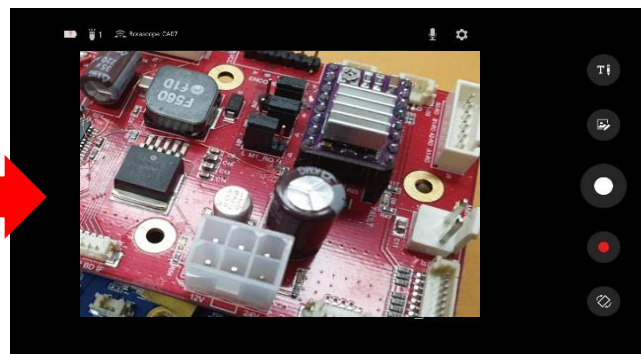
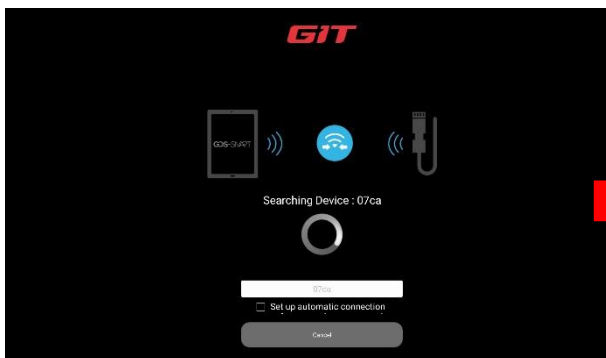

# Screen Description

## Recording Screen

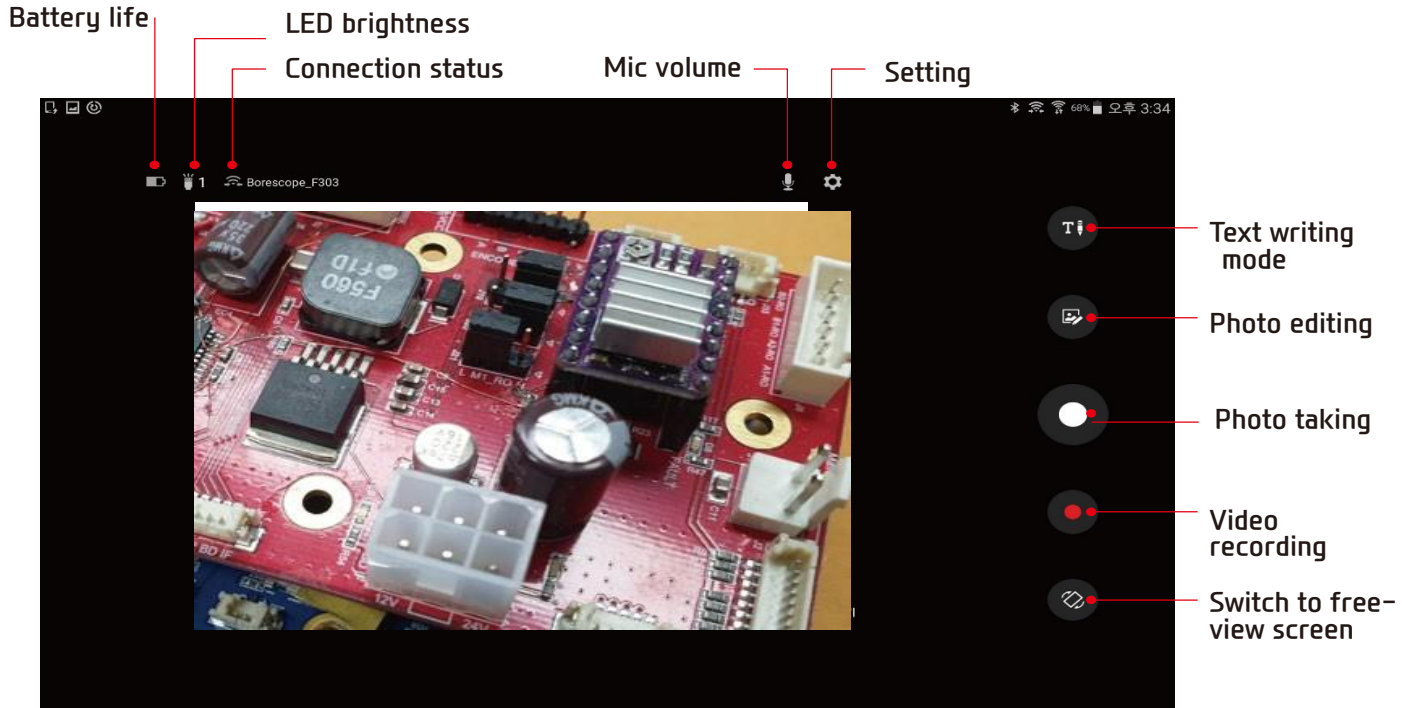

Function	Description
LED brightness	You can adjust the screen to a desired brightness by pressing LDF Brightness Adjustment button.
Setting	You can configure the resolution of the photo to be taken, as well as required time for entering the power-saving mode.
Text writing mode	You can write a memo on the captured screen.
Photo editing	You can edit the captured photo using a pen or textbox.
Switch to free-view screen	You can rotate the free-view screen by 90° each time.

## Battery Replacement

1. Use a driver to rotate the screw on the rear side in counterclockwise direction.

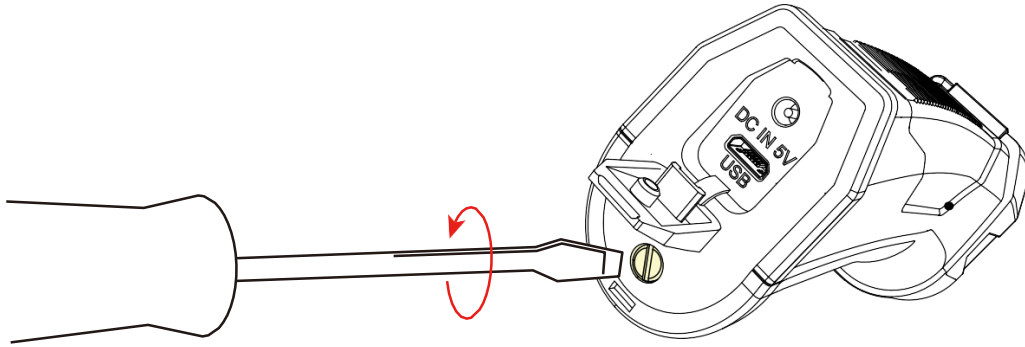

2. Take out the screw, and disassemble the batter cover on the handle side downwards.

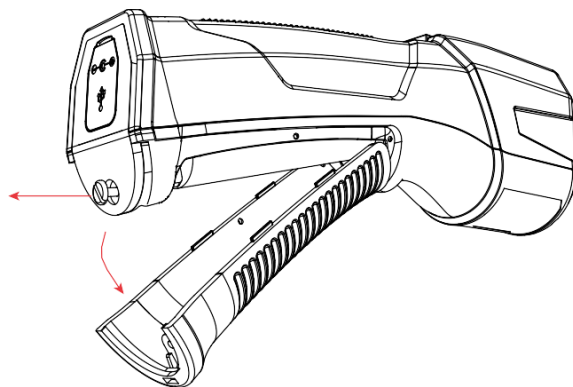

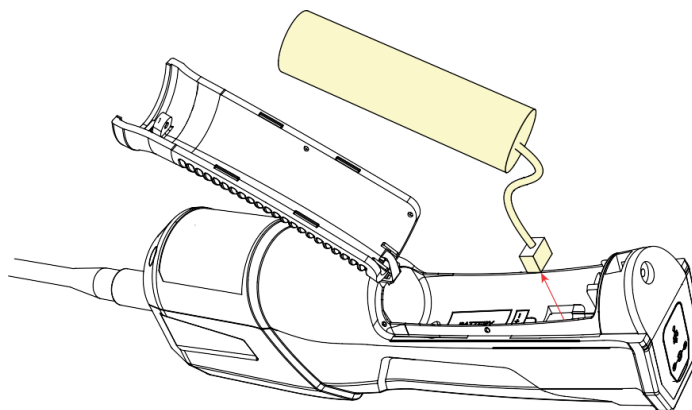

3. Take out the battery and replace it with a new battery.



## Product Specification

Item	Details
Camera	2 EA [front view (0°), side views (90°)]
Resolution	C-MOS [640X480, 800X600, 1,280X960]
Lens	Angle of view: 67°/ Aperture: F2.8 None AF/Antifogging coating
Focus range	9.5 to 300 mm
LED	White Chip LED 6 EA
Outer diameter	Camera Head Ø8.2 Camera Joint Wire Ø8.0
Product length	1 m
Magnetic holder	2 EA [front view (0°), side views (90°)]
3 Regions segmentation assembly	Camera/Flexible Tube/Main Body
Brightness adjustment	Adjusted from the hardware (3-phase)
Camera connection type	Wi-Fi Direct (Wireless LAN IEEE 802.11 b/g/n) USB (UVC 1.1)
Battery capacity	2,600 mAh
Use temperature	-20 °C ~ +70 °C
Dust-proofing/moisture-proofing	IP64

## Certifications

	The wireless device has a possibility of having a radio interference during its operation.
	This device complies with part 15 of FCC Rules. Operation is subject to the following two condition: (1) This Device may not cause harmful, and (2) This device must accept any interface received, including interface that may cause undesired operation.
